

WIDE DYNAMIC RANGE
LOCAL HDD STORAGE
GIGABIT ETHERNET
MULTI-STREAM
JPEG2000
1" CMOS
P-IRIS
AUTO SHUTTER
AUTO BACK FOCUS
RAW FORMAT SUPPORT
200 MP - 20 FPS
ONVIF
POE P-IRIS
CMOS SENSOR
LOCAL HDD STORAGE
TRIPLE OPTICAL FILTERS
GIGABIT ETHERNET
RAW FORMAT SUPPORT
PROGRESSIVE SCANNING
UPS BUILT-IN
16-PORT GIGABIT SWITCH
GIGABIT ETHERNET
UPS BUILT-IN
HYBRID ANALOG/IP
UP TO 20 HDD
MULTI-STREAM TRANSMISSION
ERROR-TOLERANT FILE SYSTEM
HYBRID ANALOG/IP
UP TO 20 HDD
MULTI-STREAM TRANSMISSION
ERROR-TOLERANT ANALYSIS
UP TO 20 HDD 160 TBYTE STORAGE
7000 MBPS RECORDING SPEED
MULTI-STREAM TRANSMISSION
200 MPIXEL PANORAMIC IMAGE
POINT-AND-CLICK PTZ
FLEXIBLE DOWNLOAD MANAGEMENT
LOGI-ZOOM
ONVIF WALL-ZOOM
LOGI-ZOOM
UNLIMITED OPERATOR PROFILE
THUMBNAILED DISPLAY
POST-PROCESSING
VIDEO STREAM PROXY
ONVIF WALL-ZOOM
LOGI-ZOOM
EVENT TRIGGERED CAPTURE
PANORAMA STITCHING
200 M
FLEXIBLE
ONVIF
THUMBNAILED DISPLAY

LOGIPIX

CATALOGUE 2016

www.logipix.com

LOGIPIX

CATALOGUE 2016



Now you can see

Logipix, established in 1996, is among the most innovative security device developer and manufacturer companies in Europe, that has carried out several successful projects worldwide. The main profile of our company is to create high quality professional IP based video surveillance systems, using the latest microelectronic and IT technology obtainable.

The revolutionary solutions of LOGIPIX Video Surveillance Systems bring a new quality to the world of security. Our groundbreaking IP cameras, Network Video Recorders and Control Center software work in cohesion to ensure a reliable end-to-end solution. Our systems are scalable according to different customer needs and they can be extended easily in case of any future development. Logipix camera family covers a broad range of resolution from Full HD to hundreds of megapixels, thus our devices are able to serve the needs of any industry with the best quality available.

End-to-end system
from cameras to VMS



IP CAMERAS



NETWORK VIDEO RECORDER

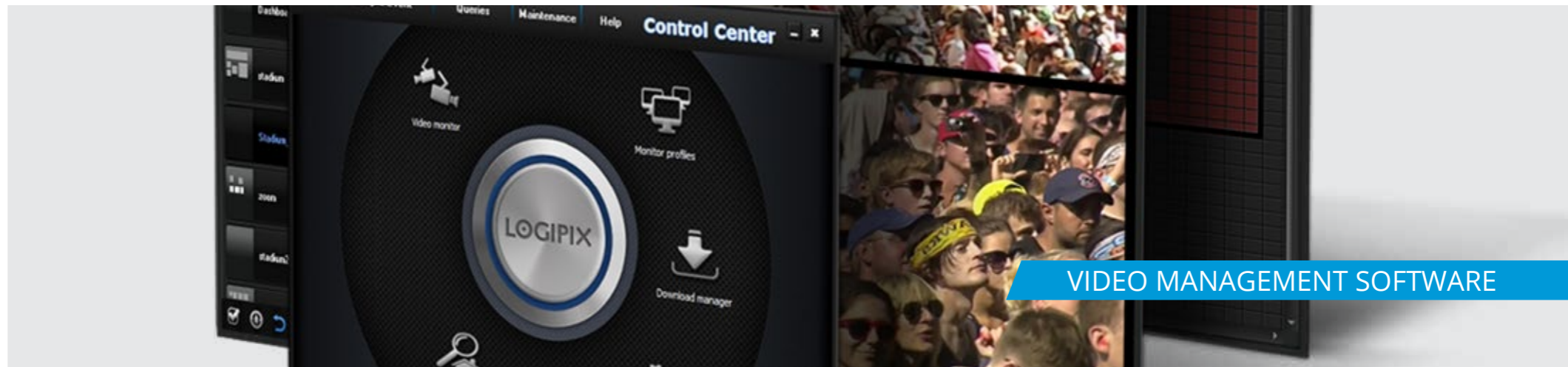

VIDEO MANAGEMENT SOFTWARE



Dynamic images where in every detail is an accurate imaging of reality

Whether you need to recognize the face of an individual in a dense crowd or a license plate of a violating car in tricky light conditions, LOGIPIX provides exceptionally easy and fast solutions.



High frame rate with multi-megapixel resolution

LOGIPIX System gives the impression of continuous motion in even a multi-megapixel resolution video stream both in live and archive. Operators can work comfortably and confidently without missing any crucial frame with a resolution that is several times higher than full HD.

An economical approach to video surveillance

You can replace dozens of full HD cameras with only a few multi-megapixel Logipix devices, significantly reducing installation and maintenance cost and even saving money on the hardware part of the system. The intuitive video management software also saves valuable training time.

Reducing lifetime TCO of the surveillance system

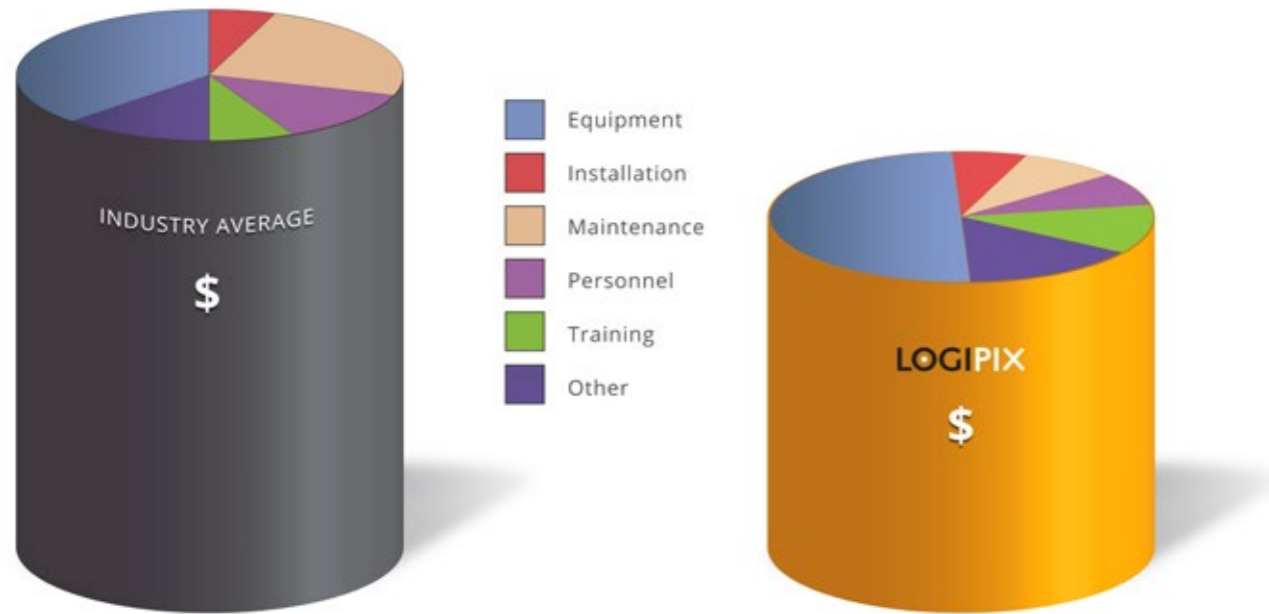

Price of a pixel in a surveillance system

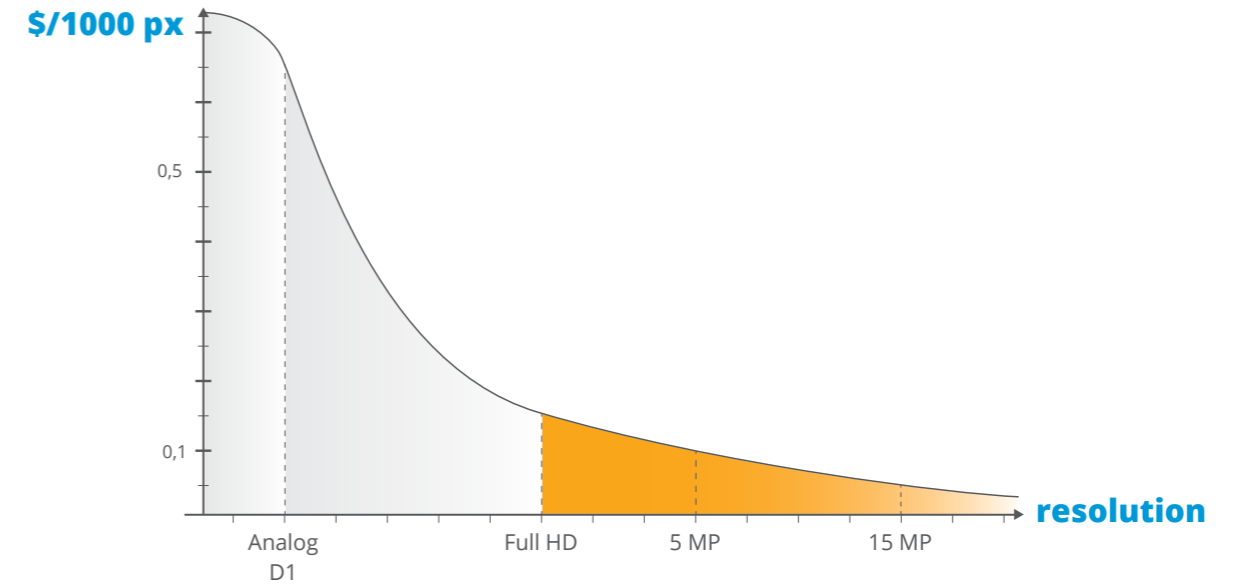

Optimizing operators' time management

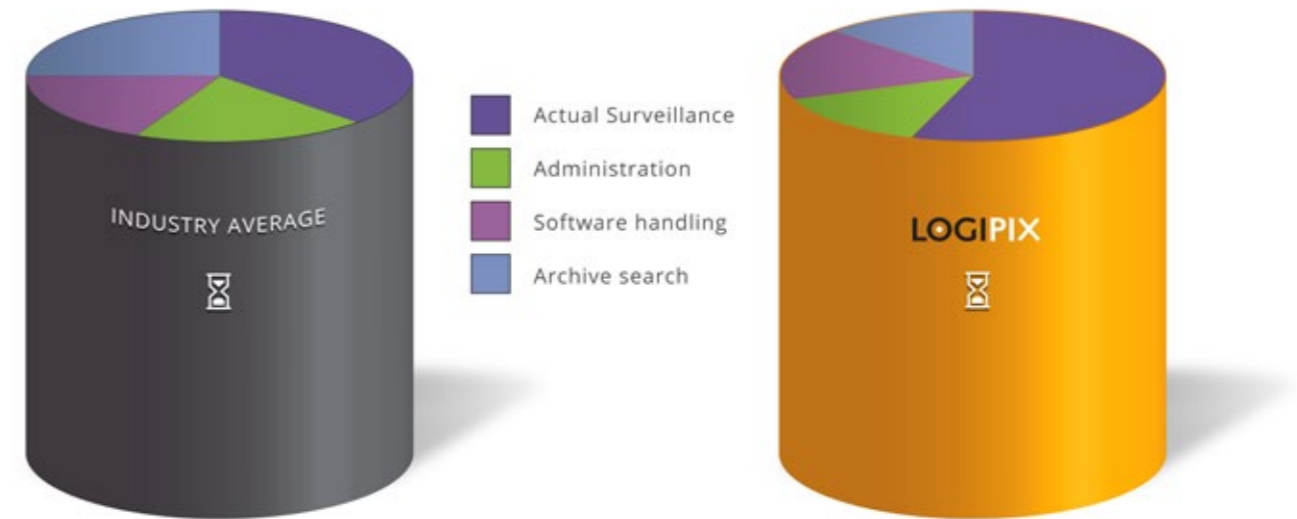

Application areas

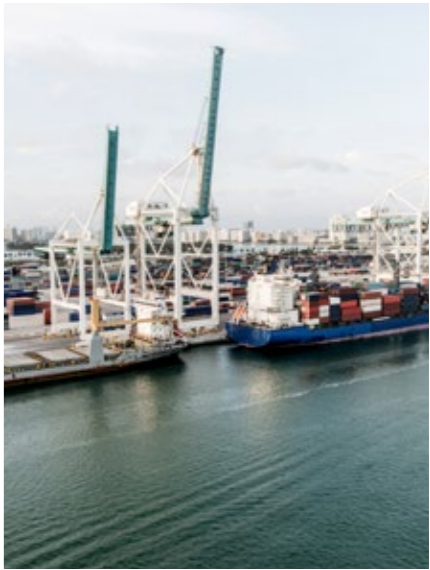
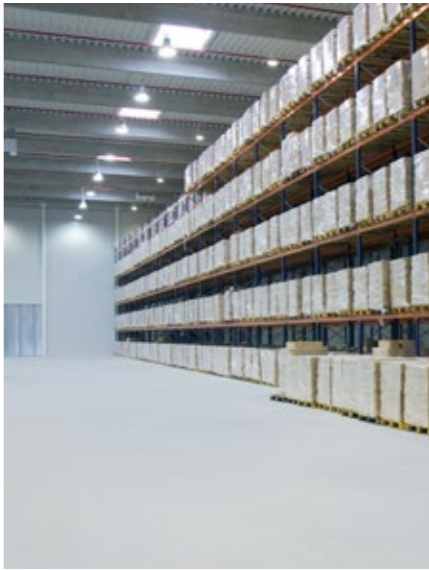

Stadium Video Surveillance

Monitoring tens of thousands of people continuously, preventing violent incidents, ensuring the safety of the spectators, staff and football players.

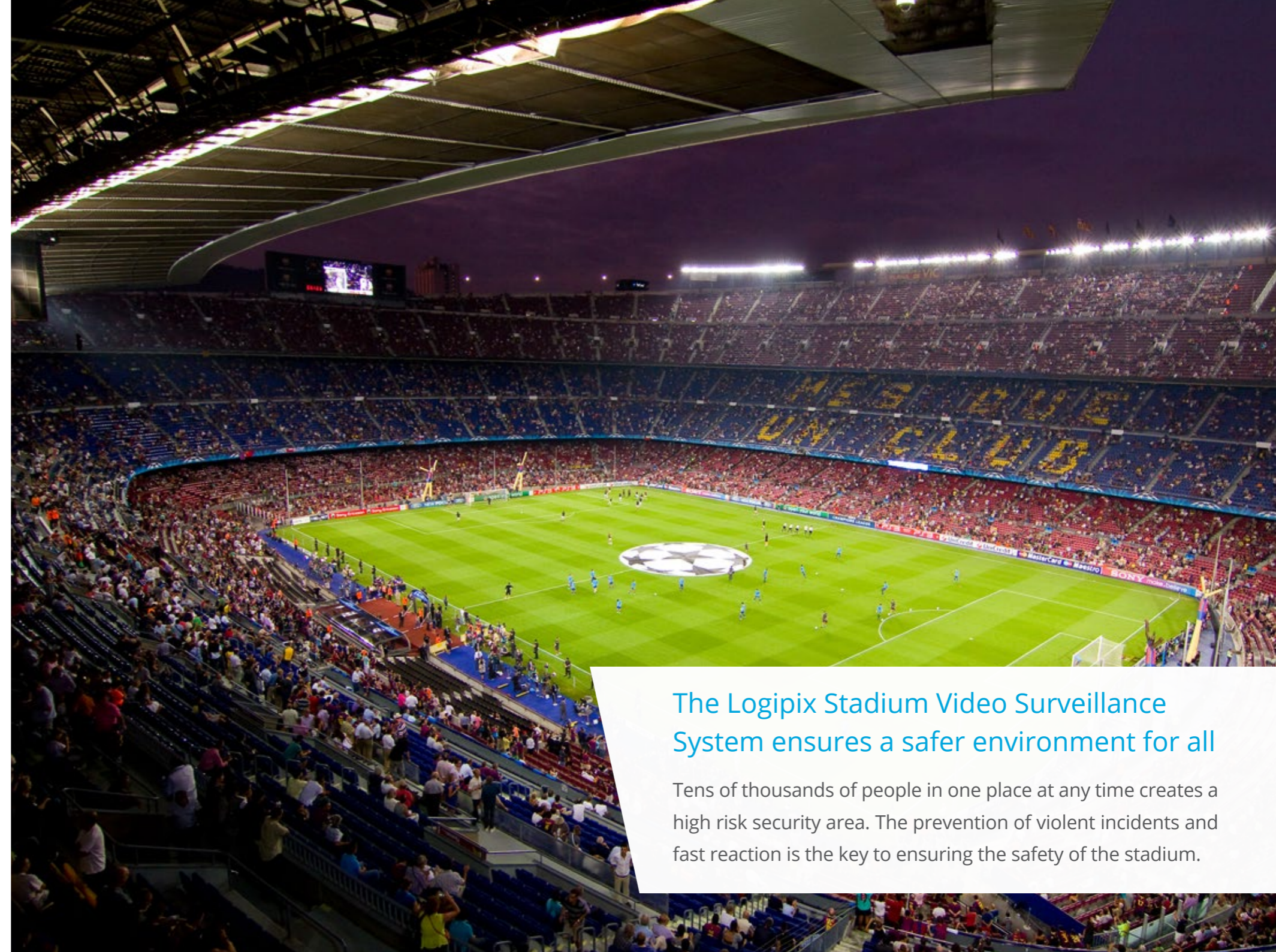

The Logipix Stadium Video Surveillance System ensures a safer environment for all

Tens of thousands of people in one place at any time creates a high risk security area. The prevention of violent incidents and fast reaction is the key to ensuring the safety of the stadium.



Permanent footage of every seat

Several individual 15 Megapixel LOGIPIX cameras cover the stadium and ensures a resolution high enough for face recognition. Their pictures are stitched together to create a panoramic view. Having large panoramic images means the security team can best assess any potential threats, and effectively manage the situation in case a quick escalation is needed.



Due to the flexibility of mounting individual cameras, the system can easily be reconfigured in case of any future developments.

Get more details thanks to the revolutionary technology

Additional Logipix Full HD PTZ cameras work together with the panoramic system and permanently scan the various sectors of the stadium. Operators can interactively control the PTZs by arbitrarily pointing areas on the panoramic images.



City Surveillance

Ensuring the safety of the citizens and public property in contemporary urban environments, creating irrefutable video evidences for the court.

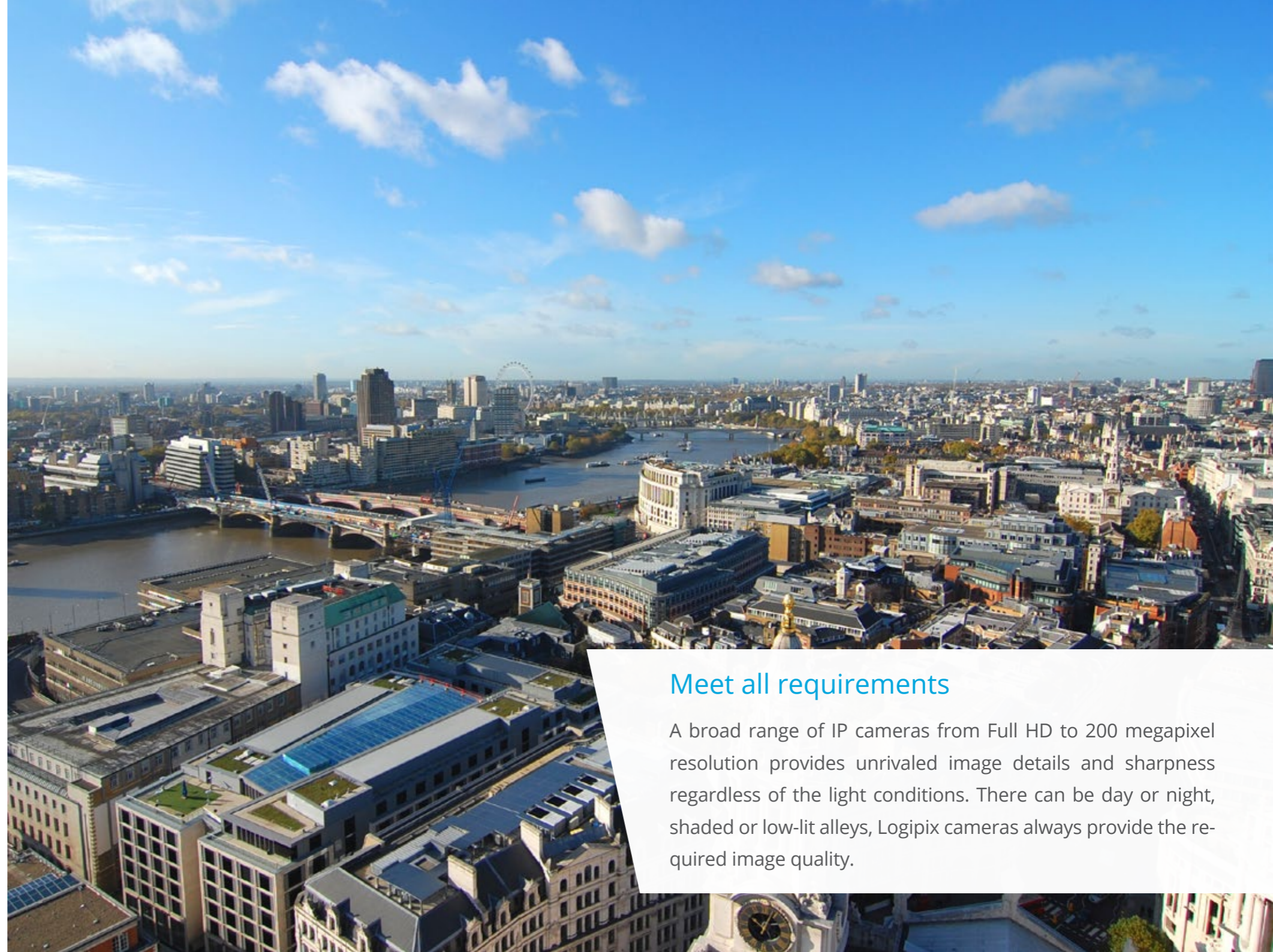

Meet all requirements

A broad range of IP cameras from Full HD to 200 megapixel resolution provides unrivaled image details and sharpness regardless of the light conditions. There can be day or night, shaded or low-lit alleys, Logipix cameras always provide the required image quality.

Effective video management

The industry's most versatile video management software allows you to have a thorough system control. Although the program has several functions, the software interface is very straightforward and user-friendly, allowing to save valuable training time and costs on your side. Multiple Control Center clients can operate in a citywide surveillance system at several workstations.



Intelligent solutions

Advanced Video Content Analysis applications help the surveillance work, able to find and capture any violations and suspicious events occurring in the city (e.g. public property damage, abandoned objects, etc.). The captured videos can be searched back easily and downloaded straight away to make irrefutable video evidences.

Traffic Surveillance

The various video content analysis applications developed by Logipix engineers can easily detect and record traffic violations, providing undoubted video evidences for local authority.

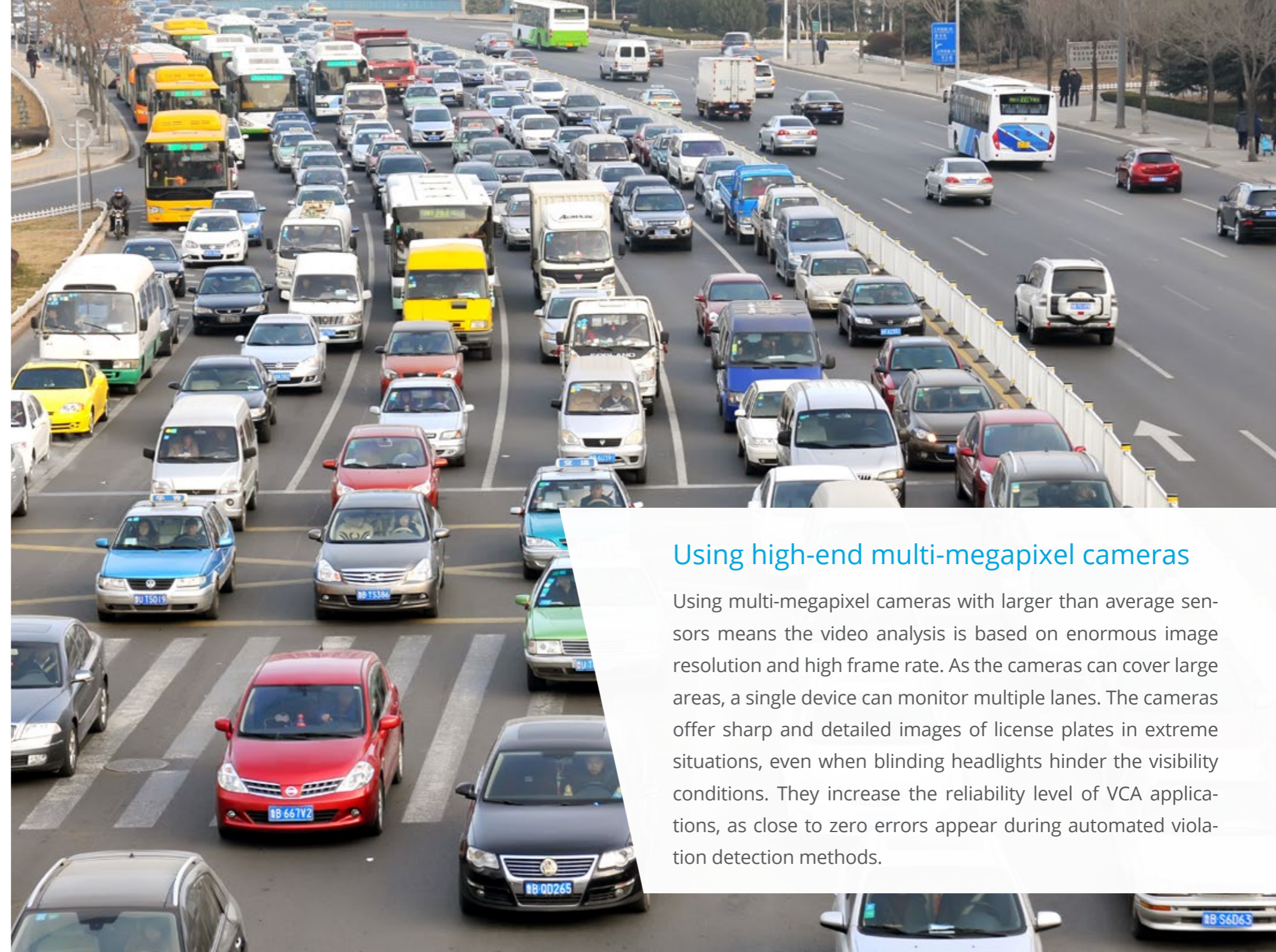

Using high-end multi-megapixel cameras

Using multi-megapixel cameras with larger than average sensors means the video analysis is based on enormous image resolution and high frame rate. As the cameras can cover large areas, a single device can monitor multiple lanes. The cameras offer sharp and detailed images of license plates in extreme situations, even when blinding headlights hinder the visibility conditions. They increase the reliability level of VCA applications, as close to zero errors appear during automated violation detection methods.

LOGIPIX traffic surveillance functions:

- Speeding detection
- Red light violation detection
- Stop line violation detection
- One-way traffic violation detection
- Bus lane violation detection
- Wrong way traffic violation detection
- Traffic Counting

Automatic red light violation detection

Violating the red light law is one of the most dangerous situations in everyday traffic. Logipix is capable to detect and identify the violating vehicles with unmatched accuracy no matter if the cameras should work in pitch black or fully sunlit light conditions. The system performs the violation detection 24/7 automatically, operators are only burdened by the verification process.



Logipix stop line detection

Stop sign traffic rule violations highly endangers other vehicles and even human life in city traffic. Logipix Stop Line Detection application ensures the automatic detection of every violating vehicles based on its precise analysis. Downloading the video can be performed either manually by the operator or automatically, triggered by the event. Should the need arise to deliver legal proof, the images of the high resolution cameras provide irrefutable video evidences.

The Logipix Traffic Surveillance System

VIOLETION MANAGEMENT CENTER

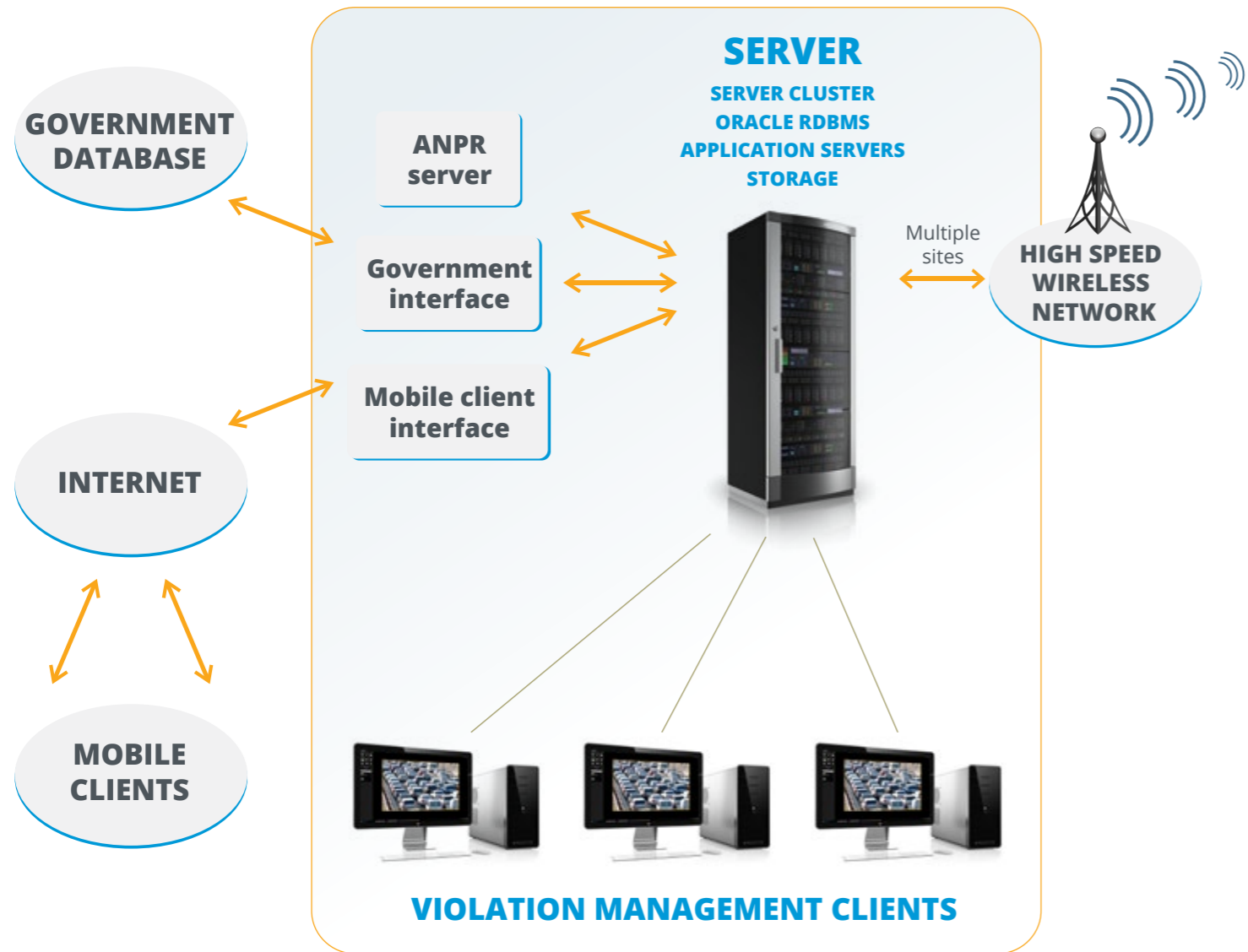

ON-SITE SYSTEM STRUCTURE

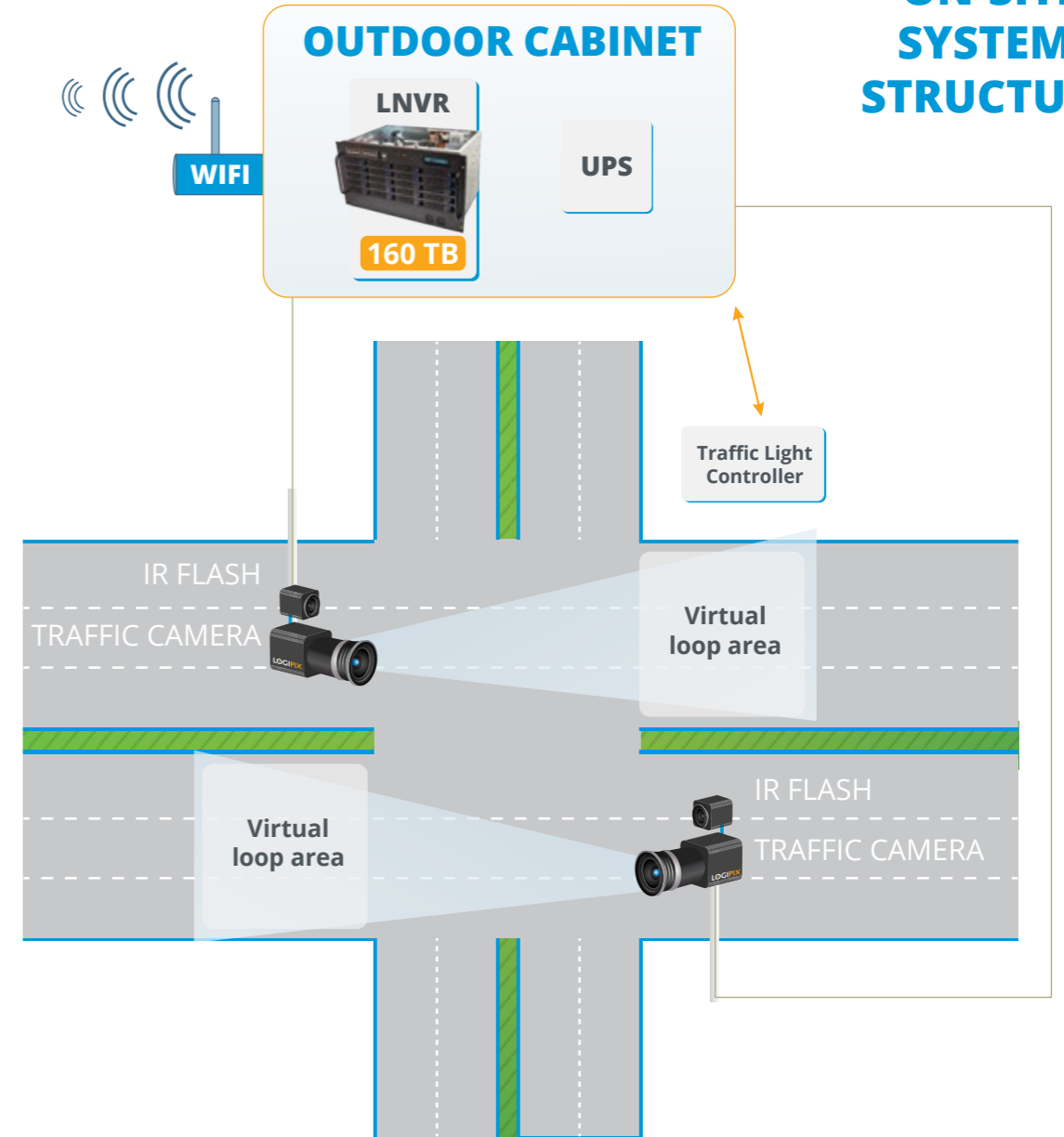

End-to-end workflow

Logipix traffic solutions do not stop at taking pictures. The operation of the system covers the entire workflow from violation detection and recording to traffic citation. The seamless integration with Logipix ANPR and external government databases enables an automatic identification of the violating vehicle. Operators only need to confirm the automatically created violation packages.



Violation Management Client

The violation packages are processed by operators in the Violation Management Client. This is an extremely user-friendly software, designed to confirm the automatically detected traffic violations. The aim of the software is to effectively process the largest number of violations with the smallest human effort. It helps to reach the 10,000 citations/24hours/workstation.

Control Center

LOGIPIX has developed a high-performance video management software, which satisfies all the needs of a contemporary video surveillance system. Control Center is a part of a complex system using multi-tier architecture, providing end-to-end management and operation of the surveillance system.

The software offers a broad range of efficient functions for user friendly system administration and to acquire irrefutable video evidences. Whether a small system or a complex site with hundreds of IP cameras, Control Center never tires to perform surveillance tasks and eases the work of the operators.



Device registration within a minute

Even in a large scale system, registering devices takes only a few clicks with the user-friendly interface of the Control Center.

Device setting automation

Camera parameters can be set at once for any number of devices via copy and paste functions, significantly decreasing the time required for setting up the system.

Transparent monitor profiles help the work of the operators

Camera images can be arranged into several monitor profiles, and switching between them takes no time. Monitor profiles can be configured to include camera images from different recorders.



Minute details of any critical threads



Multiple zoom objects can be placed on the monitor profile showing selected high quality zoomed images of the camera pictures parallel to the original field of view. The Logi-zoom function allows to observe the tiniest details in the picture even over a low-bandwidth network.

Three monitoring modules

The software offers three different modules for the display of surveillance tasks: Video Monitor, Map and Event Display. By combining these views and using the one appropriate for the task to be completed, operators' efficiency is greatly enhanced.



Simple and fast control of the PTZ cameras

Control Center offers an interactive control of PTZ cameras, either on their own camera image or on the panoramic images. A click on the desired position, and the PTZ camera turns to and optically zooms in the selected area.

Panoramic camera features

Individual, fixed LOGIPIX camera images can be stitched to create a panoramic view. The Control Center uses the computer's GPU through OpenGL to merge the pictures of up to 16 cameras, with a combined image size of about 200 MP. LOGIPIX panoramic cameras can also be easily configured by the Control Center.



No one can hide

Four different motion-sensitive areas can be specified on the camera picture. No one can enter the monitored area without noticing. The incident can trigger various reactions from higher quality recording to displaying special capture camera picture.

Intelligent image display

The system can link displaying camera images to various events. For instance if an alarm signal is identified, the related pictures are going to be displayed on the Video Monitor.



Efficient search back for evidence

Playing back archive recordings in the Video Monitor is quick and easy, even from several camera sources simultaneously. The user friendly video control panel allows for a fast search of the event to be explored, while the activity diagram helps to find the critical situation.



Video stream download features

The operators can download recordings into Download folders on the server computer. Downloaded recordings can be filtered and sorted and required recordings can be played back or saved to a specific location. At playback, the events logged to the recording are displayed side-by-side. Besides user-initiated downloads, Control Center also features event-driven or scheduled copy of the recordings.

Immediate security footage download

Immediate download of recordings can be performed with a single click. Upon noticing an incident on the video monitor, pressing a button is sufficient for the video recording to be downloaded immediately with the predefined parameters.

Multiple Control Center clients without additional load on the network

If multiple Control Center instances are running, a Video Proxy Server is required. The Video Proxy Server optimizes network bandwidth so that multiple clients can be run simultaneously, without overloading the network.

Control Center server functions

Function Description	Basic	Pro
SERVER LICENSE		
EM server*		X
VideoProxy / multiple client mode / limited Only to use DM manager	X	
VideoProxy / multiple client mode / extended Video cache, required to use DM manager		X
CC Program user management / detailed	X	X
Alarm Client support up to 2 clients	X	X
Alarm Client support over 2 clients		X
Separate bandwidth limit for each NVR	X	X
Authorization per cameras to watch the live pictures	X	X
Authorization per cameras to watch the archives	X	X
Authorization per cameras to download the archives	X	X
Sending e-mail	X	X

*In case of using the EM server, not all the Control Centers connect to the device individually, but only the EM server. Communication is realized through the server. In case of multiple sites, the sites don't have to communicate directly with each other for displaying. Required for the Event Grid (log based). Required to save the Capture video automatically.

Selected Control Center Client functions:

Function Description	Basic	Pro	Ext.
CLIENT LICENSE			
Camera configuration Logipix and Analog cameras	X	X	
Camera configuration Logipix, Logipix-PTZ, ONVIF and Analog cameras		X	
Monitor profiles	X	X	
Archive playback	X	X	
LPayer for archive files	X	X	
Multi-monitor mode		X	
Importing device from file		X	
Motion-sensation in 3 areas	X	X	
Copy camera configuration		X	
Control by touchscreen gestures	X	X	
PointIT PTZ control		X	
Picture-in-picture		X	
Digi-zoom	X	X	
Zoom history		X	
Image post-processing		X	
Print picture	X	X	
Save picture	X	X	
PANORAMA DISPLAY			
From a single NVR / X cameras / 1 panoramic image		X	
From several NVRs / optional cameras / several panoramic images		O	X
STADIUM FUNCTIONS			
Stadium background model		O	X
Interactive PTZ control on the Panoramic image		O	X
Event start and close		O	X

Hardware components



LOGIPIX NVR



LNVRs are the high speed network video recorders of the LOGIPIX system. All models are both fast and easy to configure with the user friendly video management software. The devices have a built-in 16 channel LPoE router for direct camera connection. The LOGIPIX Network Video Recorders are able to manage both H.264 and JPEG2000 encoded video streams, the latter of which provides a quality unparalleled in video surveillance. The recorders' storage capacity can extend up to 160 TBytes, with a recording speed of 1600 Mbit/sec, which is 4 times faster than that any other NVR can currently provide in the industry. With the built-in LPoE router, a VRM fail-safe file system and the built-in UPS, trouble-free recording is ensured.

	LNVR-16-4-B	LNVR-16-8-B	LNVR-16-8	LNVR-16-20	LNVR-16-8-E	LNVR-16-20-E
Number of cameras	16 (32 with extended license)					
Number of HDDs	4	8	8	20	8	20
Storage	Up to 32 Tbyte	Up to 64 Tbyte	Up to 64 Tbyte	Up to 160 Tbyte	Up to 64 Tbyte	Up to 160 Tbyte
VRM Fail-safe File System	Yes					
Built-in RAID function	Yes					
Built-in managed UPS	Yes					
Batteries	Internal 2x12 V/12 Ah	Internal 2x12 V/12 Ah	External 4x12 V/20Ah	External 4x12 V/20Ah	External 4x12 V/20Ah	External 4x12 V/20Ah
LPoE router	Yes					
100 Mbit LPoE camera port	16	16	16	16	16	16
1000 Mbit Ethernet slot	2	2	2	2	4	4

	LNVR2-10-8 / LNVR2-16-8	LNVR2-10-8 / LNVR2-16-8
Number of cameras	10 / 16 (LOGIPIX ONE)	10 / 16 (LOGIPIX ONE)
Number of HDDs	8	20
Storage	Up to 64 Tbyte	Up to 160 Tbyte
VRM Fail-safe File System	Yes	
Built-in RAID function	Yes	
Built-in managed UPS	Yes	
Batteries	External 4x12 V/20Ah	
10000 Mbit copper / SFP port	2 (for cameras and remote monitoring)	

LOGIPIX ONE



After a point, the number of megapixels gradually loses importance. What really counts in picture quality improvement is the size of the image sensor. At the heart of LOGIPIX ONE cameras, cutting-edge 1 inch sensors enable the cameras to capture stunning images. With a resolution of 14 MP and 20 MP, respectively, the cameras provide more detailed images with sharper edges and improved low-light performance due to the larger sensor size. With the ability to gain more illumination information, LOGIPIX ONE is capable to provide images with less noise and enormously wide dynamic range even in low-lit environments.

Image quality improvement is not the only benefit these devices bring to the table. Logipix ONE produces a 20 fps video stream at full resolution, therefore any motion in the footage appears to be continuous.

	LOGIPIX ONE DNI ULTRA WDR	LOGIPIX ONE DNV ULTRA WDR	LOGIPIX ONE DNI	LOGIPIX ONE DNV
Resolution	4608 (H) x 3072 (V)		5504 (H) x 3648 (V)	
Frame rate	20 fps @ full resolution			
Video compression	JPEG2000 - wavelet			
Image sensor	1" color 14.2 Megapixel CMOS		1" color 20.48 Megapixel CMOS	
Scanning system	Progressive scanning			
Back light compensation	Yes			
Auto Back Focus	Yes			
LPoE	Yes			
I/O	4 programmable IO connections NO, NC / OC 0.5A/30V			
Sound	Built-in microphone, 1 ch external 24kHz/16bit, sound in/output			
Day & Night operation	Yes			
Special operation	Moveable IR bandpass filter for IR flash	Visibility Enhancement for bad weather conditions	Moveable IR bandpass filter for IR flash	Visibility Enhancement for bad weather conditions
Wide Dynamic Range	Yes	Yes	No	No

Coverage specification example

Camera:
LPIX-ONE-20-DNI-01

Lens: LOBJ25

f: 14 - 50 mm
F: 2.6 - Close

Angle of view: (H/V)
14 mm: 50.5° / 34.6°
50 mm: 15.1° / 10.0°

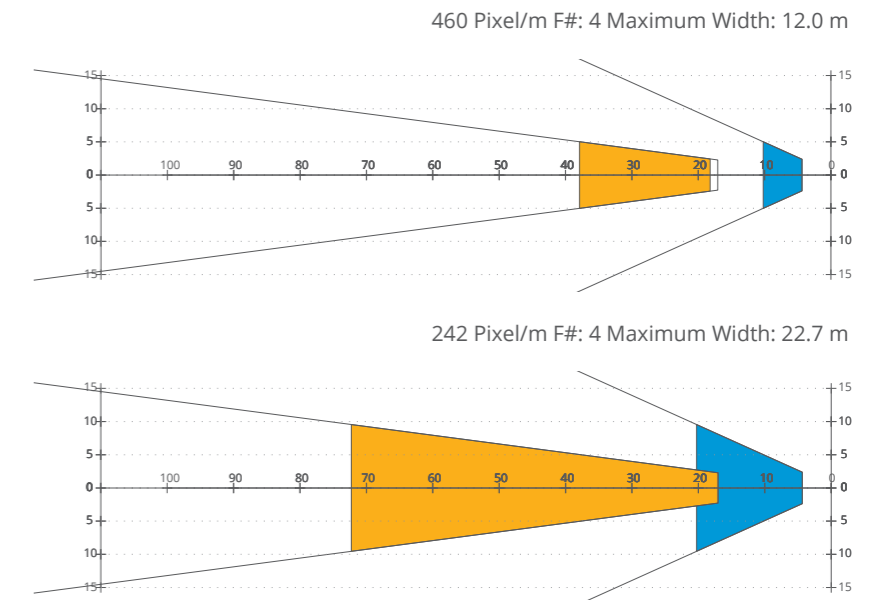

LOGIPIX PANORAMA



When extremely large-scale areas must be observed with extraordinary quality, the Logipix Multi-megapixel Panorama camera family offers the solution. The cameras deliver 140 to 200 MP resolutions with high frame rate video streams, which means a revolutionary quality improvement in video surveillance. Large panoramic images ensure an expanded view where there are neither hidden nor redundant areas and they provide permanent high quality security footage of the whole monitored area. Several hundred megapixels of visual information provides a resolution which is suitable for face recognition even from great distances.

	LOGIPIX ONE PANORAMA 140 MP	LOGIPIX ONE PANORAMA 200 MP
Resolution	140 megapixels	200 megapixels
Frame rate	20 fps @ full resolution	
Video compression	JPEG2000 - wavelet	
Image sensor	Several 1" color 14.2 Megapixel CMOS	Several 1" color 20.48 Megapixel CMOS
Scanning system	Progressive scanning	
Back light compensation	Yes	
Auto Back Focus	Yes	
I/O	8 programmable IO connections	
Sound	1 ch external 24kHz/16bit, sound in/output	
Day & Night operation	Yes	
Wide dynamic Range	Yes	No
Outdoor housing	Yes (IP66)	
Cooling system	Passive heatpipe	
Heating system	Active automatic	
Cleaning system	Wiper with washer fluid pump and internal tank (optional)	

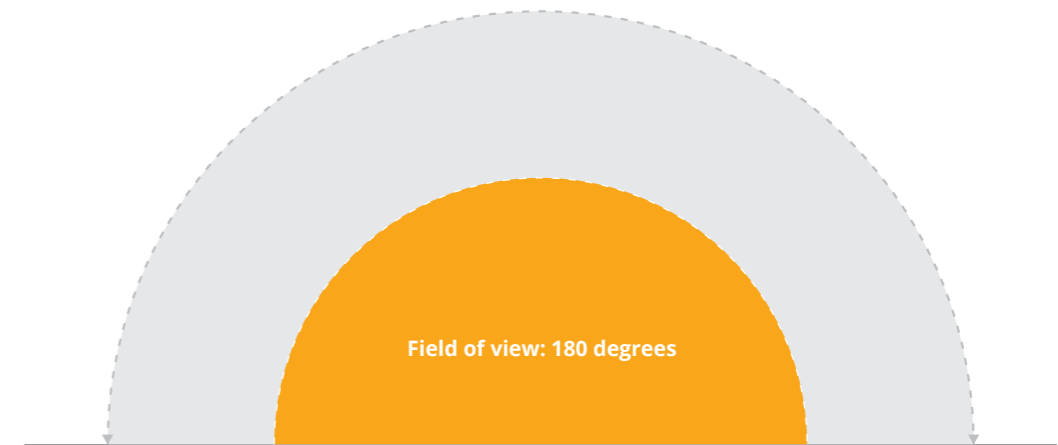

LOGIPIX 15 MP



Products in the LOGIPIX 15 MP camera family provide exceptionally high resolution. Large areas can be monitored with a single device. Experience high quality image details in varying light conditions, enjoy the unique embedded JPEG2000 multi-stream and the benefits that multi-resolution recording technology provides. LOGIPIX 15 MP camera family includes Day/Night models as well that are designed specifically for 24h video surveillance.

	LPIX15-01	LPIX15-DN-01	LPIX15-SATA-DN-01	LPIX15-02	LPIX15-DN-02
Resolution	4608 (H) x 3288 (V)				
Frame rate	5 fps @ full resolution				
Video compression	JPEG2000 - wavelet				
Image sensor	1/2" color 15 Megapixel CMOS				
Scanning system	Progressive scanning				
Back light compensation	Yes				
LPoE	Yes				
I/O	2 programmable IO connections NO, NC / OC 0.5A/30V				
Sound	Built-in microphone, 1 ch external 24kHz/16bit, sound in/output				
Day & Night operation	No	Yes	Yes	No	Yes
Local storage	No	No	Yes	No	No
Dome enclosure	No	No	No	Yes	Yes
Cooling	No	No	No	Built-in fan	Built-in fan
Heating	No	No	No	No	Optional

Coverage specification example

Camera:
LPIX15-DN-01

Lens: LOBJ19

f: 3.9 - 10mm
F: 2 - Close

Angle of view:
(H/V)
3.9mm: 78.8° / 60.7°
10mm: 35.2° / 25.5°

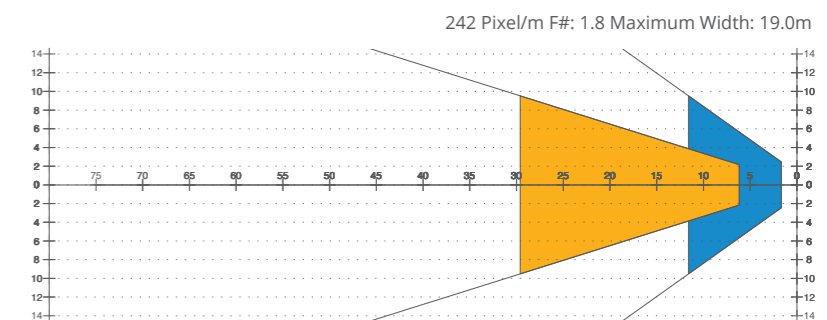
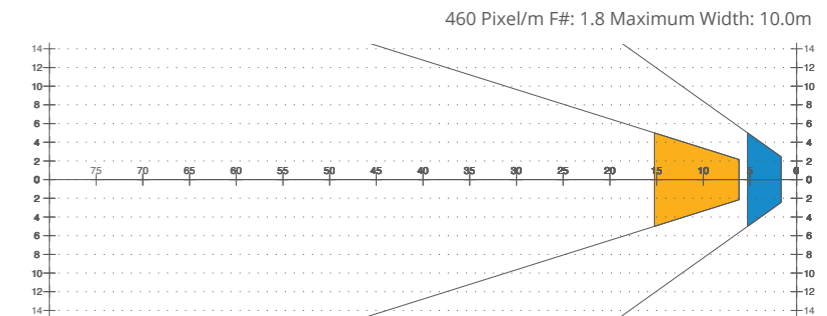

LOGIPIX 15 MP ABF



Replace several full HD cameras with a single LOGIPIX 15 MP ABF, which delivers extraordinary detailed images. When a whole large area must be monitored at once, a single device can be more effective than a series of cameras. The camera family also contains D/N models, that can automatically remove the built-in IR filter at night in order to make use of the infrared light sources as well. The Auto Back Focus module automatically changes the position of the sensor to set the right focus, and provides clear, sharp images. LOGIPIX 15 MP ABF is also available with built-in NVR function and a directly connected SATA HDD.

	LPIX15-01-ABF	LPIX15-DN-01-ABF	LPIX15-SAT-DN-01-ABF	LPIX15-02-ABF	LPIX15-DN-02-ABF
Resolution	4608 (H) x 3288 (V)				
Frame rate	5 fps @ full resolution				
Video compression	JPEG2000 - wavelet				
Image sensor	1/2" color 15 Megapixel CMOS				
Scanning system	Progressive scanning				
Back light compensation	Yes				
LPoE	Yes				
I/O	2 programmable IO connections NO, NC / OC 0.5A/30V				
Sound	Built-in microphone, 1 ch external 24kHz/16bit, sound in/output				
Auto Back Focus	Yes				
Day & Night operation	No	Yes	Yes	No	Yes
Local storage	No	No	Yes	No	No
Dome enclosure	No	No	No	Yes	Yes
Cooling	No	No	No	Built-in fan	Built-in fan
Heating	No	No	No	No	Optional

Coverage specification example

Camera:
LPIX15-DN-01-ABF

Lens: LOBJ20

f: 25 - 135 mm
F: 1.8 - Close

Angle of view: (H/V)
25 mm: 14.7° / 10.5°
135 mm: 2.7° / 1.9°

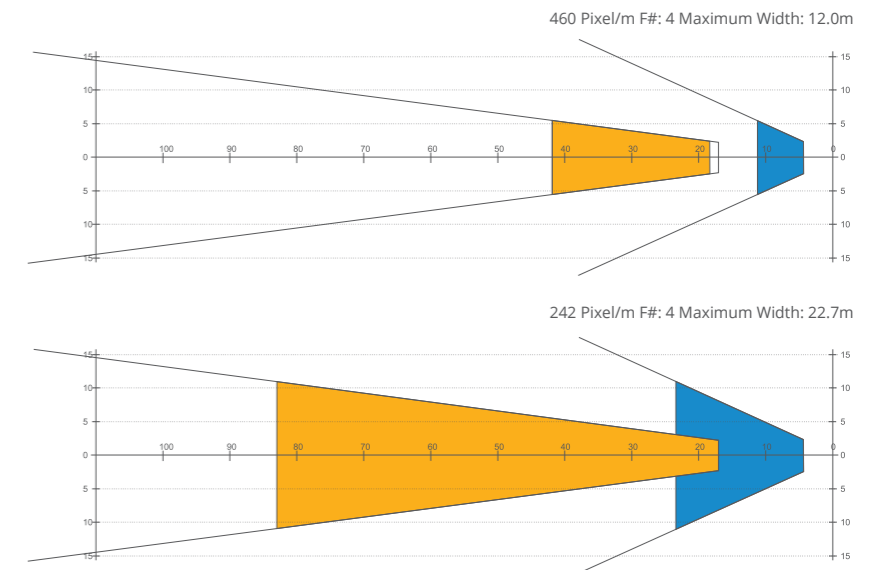

LOGIPIX 5 MP



When Full HD images are not adequate, the 5 MP camera family is the suitable solution. The devices are especially recommended to observe medium or large scale areas. As they use the effective motion-compensation based H.264 standard for image compression, a low-bandwidth network is sufficient to transmit the images.

	LPIX5-DN-01	LPIX5-DN-02
Resolution	2592 (H) x 1944(V)	
Frame rate	30 fps @ full resolution	
Video compression	H.264 & MJPEG	
Image sensor	1/2.5" CMOS	
Scanning system	Progressive scanning	
PoE	Yes	
Day & Night operation	Yes	
Camera enclosure	No	Bullet (IP66)
IR	No	Built-in illuminator
Heating	No	Yes (Built-in)

Coverage specification example

Camera:
LPIX5-DN-01

Lens: LOBJ22

f: 8 - 22 mm

F: 1.8 - Close

Angle of view: (H/V)

9 mm: 35.1° / 26.5°

22 mm: 14.8° / 11.6°

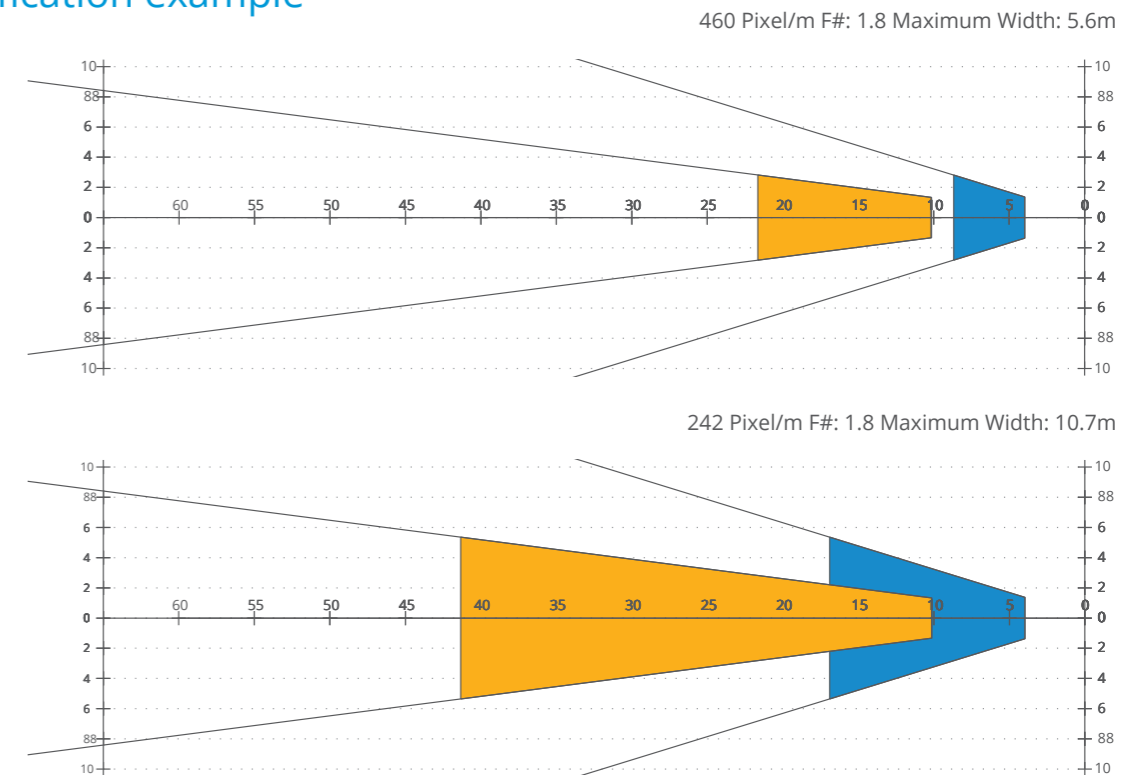

LOGIPIX 4 MP



4 MP camera family is the entry-level camera series with full HD resolution. The devices are especially recommended to monitor building entrances, corridors, parking garages, restaurants and other small scale areas. The camera family uses the effective motion-compensation based H.264 standard for image compression, which means that even a low-bandwidth network is sufficient to transmit the images.

	LPIX4-DN-01	LPIX4-DN-02	LPIX4-DN-03	LPIX4-DN-04	LPIX4-B
Resolution	2688 (H) x 1520 (V)				
Frame rate	30 fps @ full resolution				
Video compression	H.264 & MJPEG				
Image sensor	1/3" CMOS				
Scanning system	Progressive scan				
PoE	Yes				
IR	Built-in illuminator	Built-in illuminator	Built-in illuminator	Built-in illuminator	No
Camera enclosure	Bullet (IP66)	Mini Dome (IP66) vandalproof	Micro Dome (IP66)	Mini Dome (IP66) vandalproof	No
Day & Night operation	Yes				
Wide Dynamic Range	Yes (shutter)				
Lens	f=3-9 mm F=1.2 AF	f=3-9 mm F1.2 AF	f=3-9 mm F1.2 AF	f=3-9 mm F1.7 motorized	CS-mount

Coverage specification example

Camera:
LPIX4-DN-02

Lens: Built-in Dome

f: 3 - 9 mm

F: 1.2 - Close

Angle of view: (H/V)

3mm: 103.5° / 58.2°

9mm: 34.3° / 24.5°

460 Pixel/m F#: 1.2 Maximum Width: 4.2m

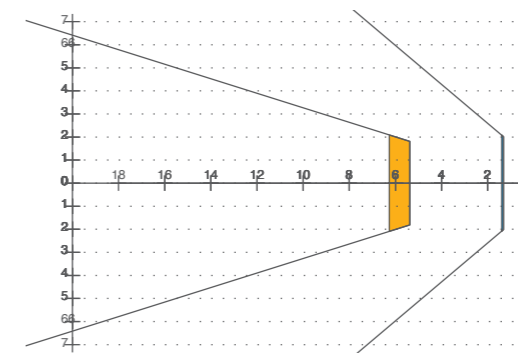

242 Pixel/m F#: 1.2 Maximum Width: 7.9m

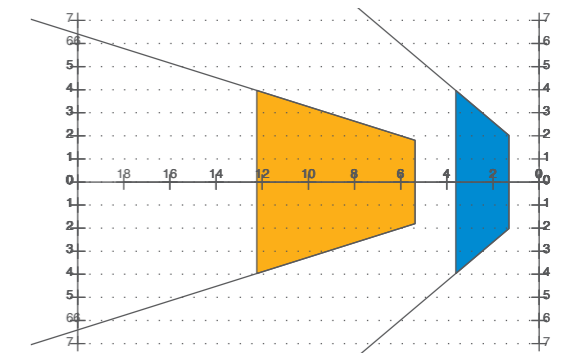

LOGIPIX FULL HD PTZ



Coverage example

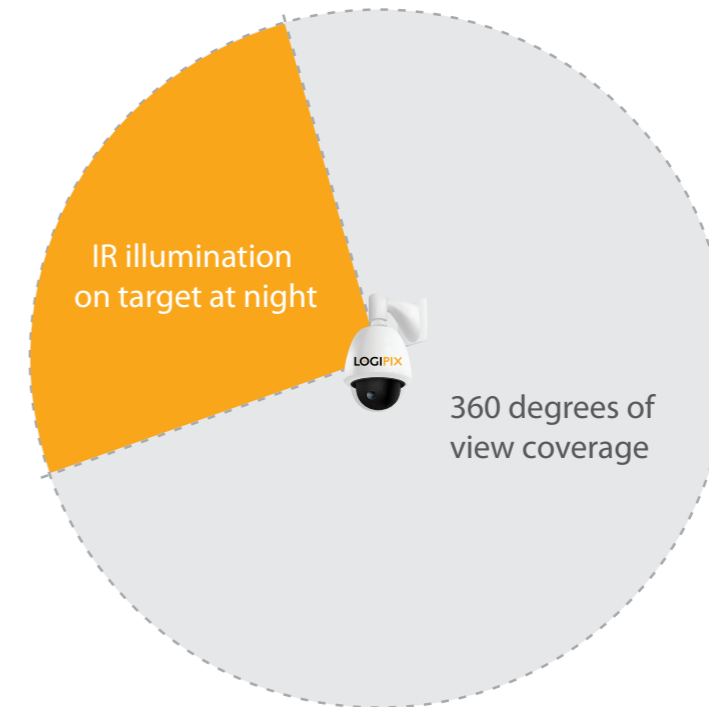

LOGIPIX PTZ ensures the clearest images with full HD picture resolution and 12 FPS recording speed. The camera provides effective object tracking due to its accuracy and incredibly fast positioning. Full HD picture resolution compressed by JPEG2000 standard and 20X or 30X optical zoom capability enable LOGIPIX PTZ to deliver high resolution image details of medium or large scale areas. The device has unique integrated IR illuminators with automatic cooperating focus system, therefore the camera provides stunning images of the monitored objects in the dark as well. Special Control Center functions, such as the interactive pointIT moving function or the PTZ position bookmarks can greatly facilitate the efficiency of the observation.

ONVIF IS THE KEY

The ONVIF standard ensures interoperability between devices regardless of the manufacturer in a single system. The Open Network Video Interface Forum (ONVIF) is a global and open industry forum with the goal to facilitate the development and use of a global open standard for the interface of physical IP based security products.

The LOGIPIX Network Video Recorders are able to handle the pictures of ONVIF cameras. Logipix NVR requests H.264 video stream from the ONVIF cameras, stores it in VRM fail-safe file system and transmits it to the Control Center. ONVIF PTZ cameras can be managed in the system as well. There is possibility to set individual passwords for the operators to get access to control the PTZ cameras.

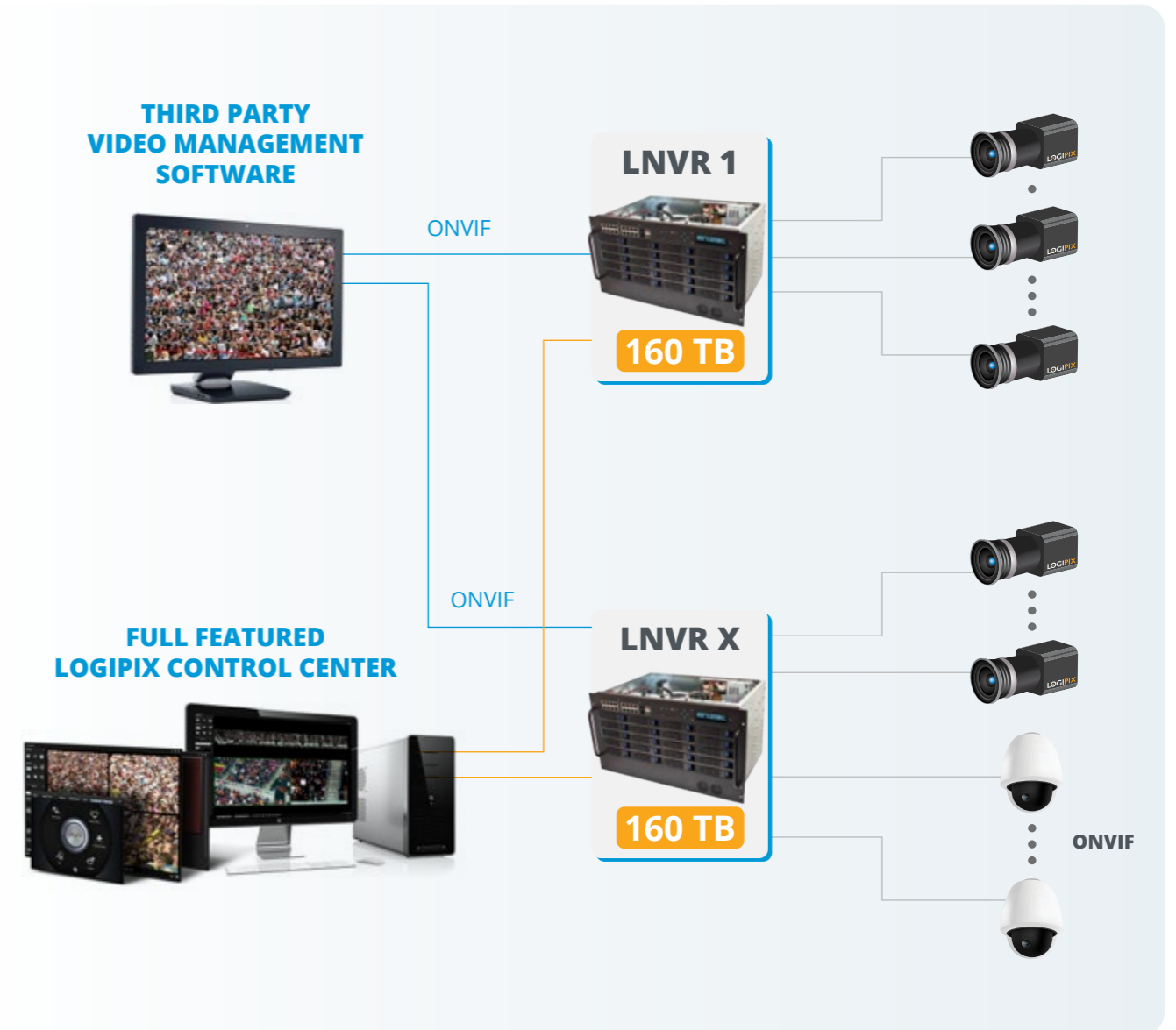

LOGIPIX Mobile Video Recorders

LOGIPIX Mobile Video Recorders are small triplex digital video recorders with low energy consumption. Walk-DVRs and Walk-NVR provide all the services that traditional DVRs do, but owing to their mobile design and unique features, they are suitable for special tasks.



3RD GENERATION OF WALK-DVR



All of the 3rd generation of Walk-DVRs can receive video stream from up to 8 analog cameras, as well as record the images on a notebook HDD. They use the Wavelet JPEG2000 standard for image compression and the images can be retrieved from the devices by direct computer browsing via LAN, Wi-Fi or GPRS. Depending on the type of Walk-DVR used, it can be extended with a CF card, GPRS or GPS modem. The Hybrid Video Storage System in the Walk-DVR-CF is based on measuring the acceleration and temperature. The devices allow reliable operation even in unfavorable environments, including those with a high vibration burden. Walk-DVR and Walk-DVR-GPRS are suitable for covert monitoring and are often used in places without infrastructure, whereas the Walk-DVR-CF can be used for video recording in vehicles or ATM machines.

Walk-DVR-CF 3rd generation features

- Hybrid recording system containing an HDD and 2 CF cards
- 4/8 analog cameras
- JPEG2000 compression standard
- Intelligent power management
- 4 Programmable inputs
- 4 Programmable outputs
- 4 Audio channels
- Built-in GPRS modem, 3.75G UMTS/HSPA+ (optional)
- Built-in GPS module (optional)
- RS232 (optional); RS485 (optional)
- Remote video management with free SCPlayer software or with the Control Center

Walk-DVR 3rd generation features

- Storage on notebook HDD
- 4/8 analog cameras
- JPEG2000 compression standard
- Intelligent power management
- 4 Programmable inputs
- 4 Programmable outputs
- 4 Audio channels
- RS232 (optional); RS485 (optional)
- Remote video management with free SCPlayer software or with the Control Center

1ST GENERATION OF WALK-NVR



Walk-NVR was called by the needs of today's evolving video surveillance technology as IP based security cameras are spreading more widely in the industry. Keeping in mind all the experiences and benefits of Walk-DVR generations, LOGIPIX developed Walk-NVR, a small mobile video recorder that serves both IP cameras and high-end analog cameras.

The special storage technology of Walk-NVR is based on a hybrid recording system that consist of standard notebook HDDs and an SSD. The built-in accelerometer and thermometer provides accurate data of the environment. If vibration or temperature level reaches a well defined limit the system switches off the HDDs and the recording continues only on the SSD. If the environmental conditions have stabilized, the hard drives then turn on again and the images are copied from the SSD onto the hard drive. Thus the recorder device is able to operate reliably in extreme environmental conditions as well.

Walk-NVR 1st generation features

- Hybrid recording system for 8 cameras
- ONVIF 2.0 IP cameras
- Standard and AHD analog cameras
- 2 external USB3 HDDs
- 2 internal HDDs up to 4Tbyte
- Internal M2 SATA SSD up to 1Tbyte
- 1 Gbit Ethernet
- POE powered (optional)
- Intelligent power management
- 6 digital isolated I/O
- RS485 (optional)
- Built-in GPRS modem, 3.75G UMTS/HSPA+ (optional)
- Built-in GPS module (optional)
- Active Peltier cooling system (optional)
- Remote video management with free SCPlayer software or with the Control Center

LOGIPIX ACCESSORIES

LOGIPIX Lenses

The best image sensors must be paired with the best optics. Logipix cameras are available with a broad range of high quality lenses. They have excellent optical resolution and provide stunning clarity therefore they are ideal to create the sharpest high resolution images. The product line contains both fix and zoom lenses recommended for various sensor sizes. Different focal lengths of the lenses may provide solutions for every emerging needs.



Logipix LOBJ-25



Logipix LOBJ-26



Logipix LOBJ-27

Part number	SENSOR	FOCUS	F	IRIS	MOUNT	FISHEYE
LOBJ-07	1/2"	1.4 mm	1.4	Manual	CS-mount	Yes
LOBJ-14	1"	75 mm	2.8	Manual	C-mount	-
LOBJ-19	1/2"	3.9 - 10 mm	1.8	P	CS-mount	-
LOBJ-20	1/2"	16 - 48 mm	2.0	P	CS-mount	-
LOBJ-21	1/2.7"	3.3 - 12 mm	1.6	DC	CS-mount	-
LOBJ-22	1/2.5"	9 - 22 mm	1.8	DC	CS-mount	-
LOBJ-25	1"	14 - 50 mm	2.6	P	C-mount	-
LOBJ-26	1/2"	25 - 135 mm	1.8	Manual	C-mount	-
LOBJ-27	1"	35 mm	1.4	Manual	C-mount	-

LOGIPIX IR flash

In extreme situations, when only IR lights are available for illumination, the IR flash ensures the appropriate lighting to capture clear and sharp images. Our self developed IR flasher works integrated and synchronized with the LOGIPIX camera, which contains a moveable built-in IR band-pass filter. The device lights the monitored object at every recorded frame with configured parameters. The light of the IR flasher is focusable in order to illuminate only the necessary area.



LOGIPIX Ethernet Repeater

If you have to deal with long distances between the camera and the NVR, the LOGIPIX Ethernet repeater provides the solution.



LOGIPIX Hybrid Extension

Logipix Hybrid Extension provides the opportunity to connect analog cameras to the Logipix NVR. Your existing analog cameras can be easily and quickly integrated into the Logipix Multi-megapixel Video Surveillance System.

LOGIPIX Hybrid Extensions are available in two designs. One of them is the Box mount version, the other is the Rack mount.

Depending on the number of the video inputs they can receive the pictures of 8 or 16 analog cameras.



LOGIPIX

CATALOGUE 2016

If you would like to learn more, visit www.logipix.com

